

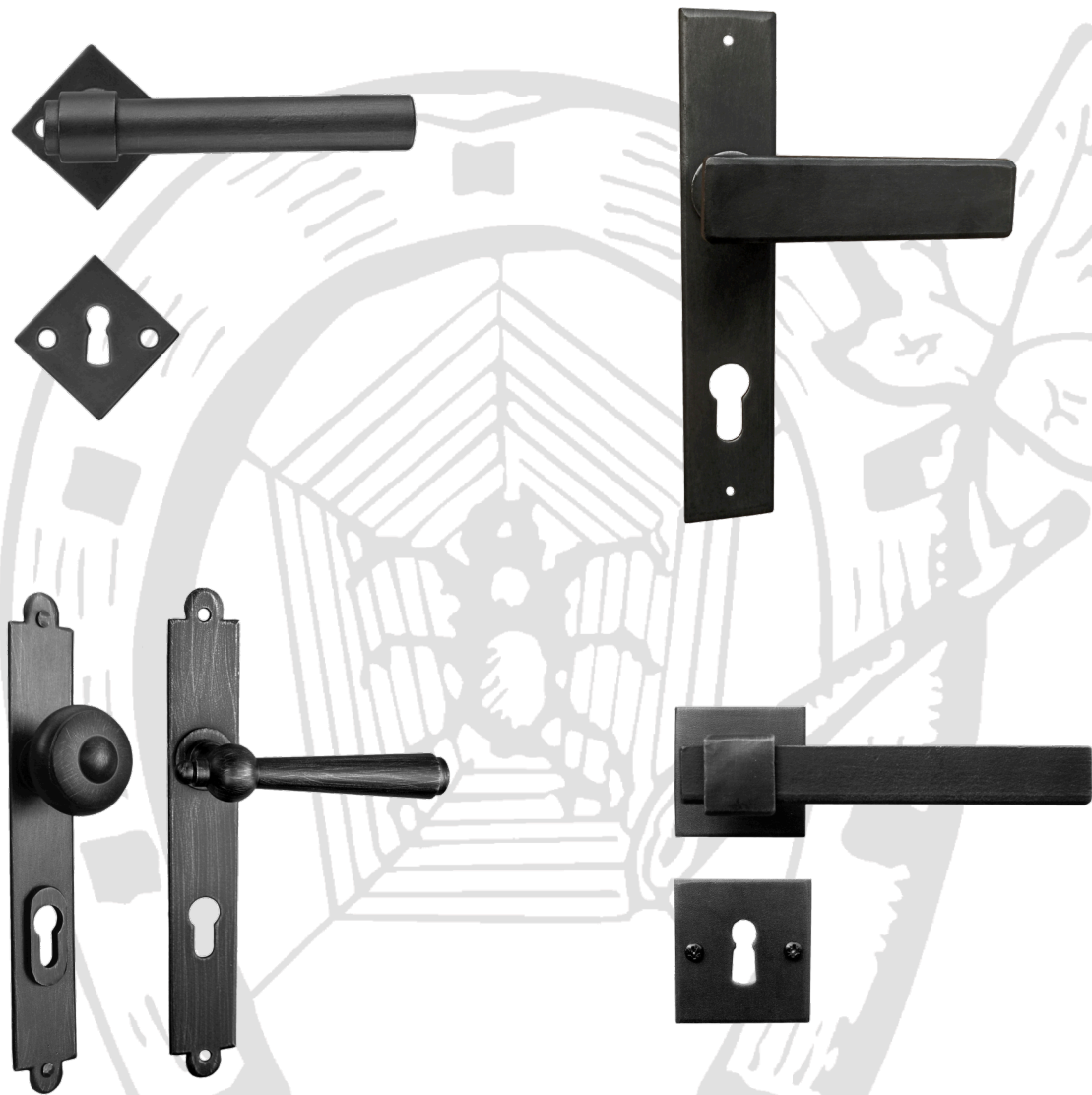

Galbusera



G. G. G.

 **ferlegno**
FERRAMENTA

Neue Produkte 2016 – News 2016

**Antikbeschläge seit 1925 –
*Architectural hardware since 1925***

Langschildgarnituren -

Door handles on backplate



Art.1815

Drückerlänge/ Handle: 100 mm
Langschild/ Plate: 220X30 mm



Art.2921

Drückerlänge/ Handle: 120 mm
Langschild/ Plate: 240X30 mm



Art.2931

Drückerlänge/ Handle: 125 mm
Langschild/ Plate: 240X30 mm

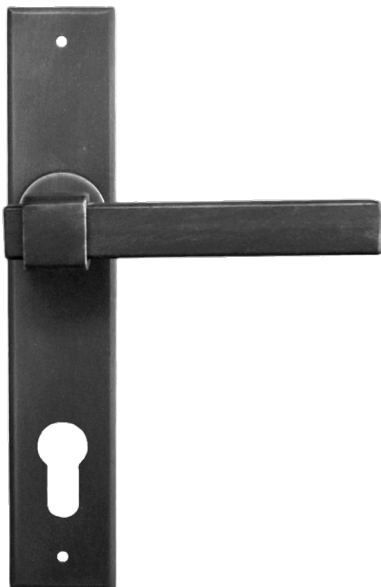

Art.1824

Drückerlänge/ Handle : 105 mm
Langschild/ Plate: 220X40 mm



Art.1814

Drückerlänge/ Handle : 100 mm
Langschild/ Plate: 220X40 mm



Art.2907

Drückerlänge/ Handle : 115 mm
Langschild/ Plate: 220X40 mm

Rosettengarnituren -

Door handles on rosette

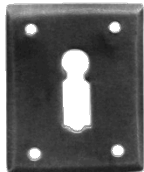
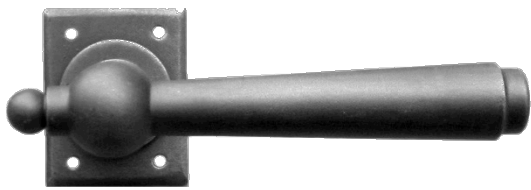

Art.2909

Drückerlänge/ Handle : 100 mm
Rosetten/ Rosette : 50x40 mm

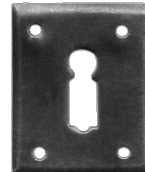
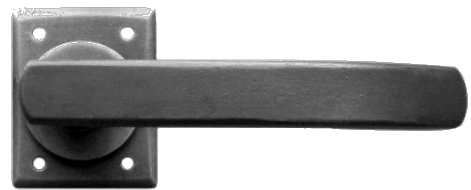

Art.1816

Drückerlänge/ Handle: 100 mm
Rosetten/ Rosette: 50x40 mm

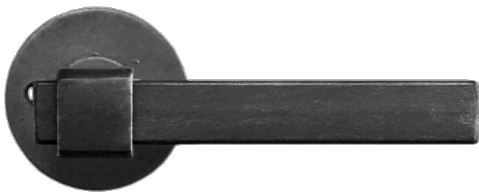

Art.1825

Drückerlänge/ Handle : 105 mm
Rosetten/ Rosette : Ø 60 mm

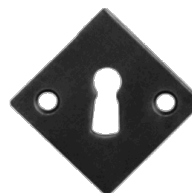
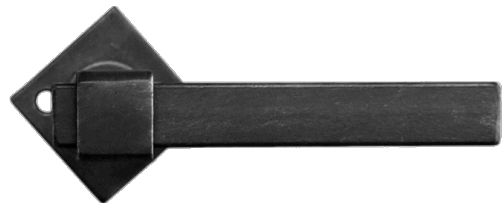

Art.1828

Drückerlänge/ Handle: 105 mm
Rosetten/ Rosette: 45x45 mm



Art.1842

Drückerlänge/ Handle : 60 mm
Rosetten/ Rosette : 70x45 mm



Art.1843

Drückerlänge/ Handle : 60mm
Rosetten/ Rosette : 60x40 mm



Art.1847

Drückerlänge/ Handle : 60 mm
Rosetten/ Rosette : 66x30 mm

Rosettengarnituren SQA -

Door handles on square rosette

Unsere neue Rosette 52x52 mm mit Durchzugsschrauben und Hülsenmuttern und Gewindenocken ($\varnothing = 8$ mm, Länge 8 mm) garantiert eine feste Montage insbesondere für die neuen industriellen Türen. Verfügbar für alle Farbe und Bohrungen. Für alle Rosettengarnituren ist der Scharublochabstand 38 mm.

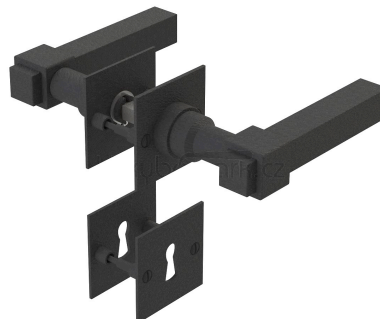
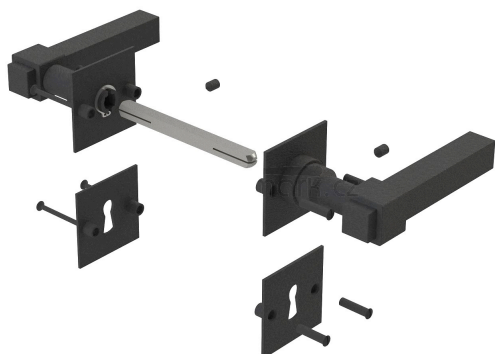

Art. 2110/SQA

Drückerlänge/
Handle: 120 mm

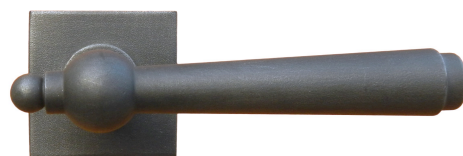

Art. 2901/SQA

Drückerlänge/
Handle: 115 mm

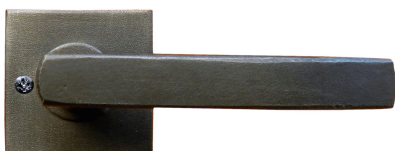

Art. 1816/SQA

Drückerlänge/
Handle: 100 mm

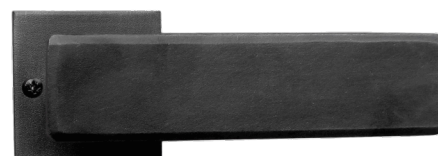

Art. 1821/SQA

Drückerlänge/
Handle: 110 mm



Art. 1825/SQA

Drückerlänge/
Handle: 105 mm

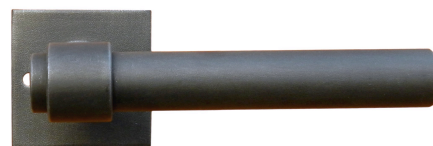

Art. 1831/SQA

Drückerlänge/
Handle: 120 mm



Art.2910

Fenstergriff 90mm
Schraubabstand 43mm
Rosette 75X30mm
Window Handle 90mm
Axe 43mm Screws M5X30
Rosette 75X30mm



Art.2922

Fenstergriff 90mm
Schraubabstand 43mm
Rosette 80X30mm
Window Handle 90mm
Axe 43mm Screws M5X30
Rosette 80X30mm

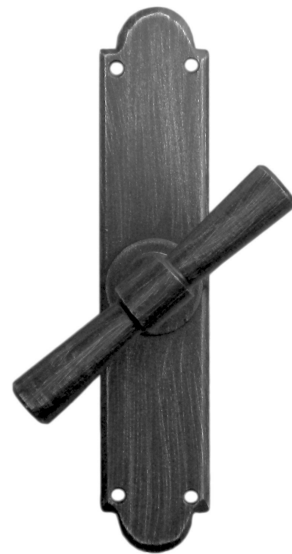

Art.2924

Drückerlänge/Handle : 82 mm
Langschild/Plate: 150x30 mm

Art.2925 mit Mechanismus
with mechanism

Drückerlänge/Handle: 82 mm
Langschild/Plate: 160x35 mm



Art.2912

Fenstergriff 115mm
Schraubabstand 43mm
Rosette 75X30mm
Window Handle 115mm
Axe 43mm Screws M5X30
Rosette 75X30mm



Art.1818

Fenstergriff 100mm
Schraubabstand 43mm
Rosette 75X30mm
Window Handle 100mm
Axe 43mm Screws M5X30
Rosette 75X30mm



Art.1827

Fenstergriff mit Rasterung
Drückerlänge 105mm
Rosette 65X32X12mm
DK Window
Handle 105mm
Raised Backplate 65X32X23mm

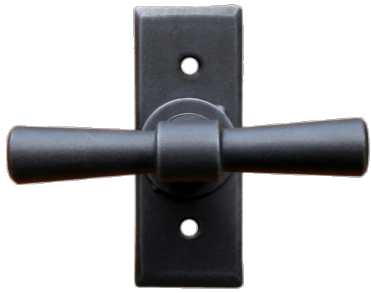
Art.2911

Fenstergriff 82mm
 Schraubabstand 43mm
 Rosette 75X30mm
 Window Handle 82mm
 Axe 43mm Screws M5X30
 Rosette 75X30mm

Art.1817

Fenstergriff 86mm
 Schraubabstand 43mm
 Rosette 75X30mm
 Window Handle 86 mm
 Axe 43mm Screws M5X30
 Rosette 75X30mm

Art.1826

Fenstergriff 100mm
 Schraubabstand 43mm
 Rosette 75X30mm
 Window Handle 100 mm
 Axe 43mm Screws M5X30
 Rosette 75X30mm

Art.2923

Fenstergriff 82mm
 Schraubabstand 43mm
 Rosette 80x30 mm
 Window Handle 82mm
 Axe 43mm Screws M5X30
 Rosette 80x30mm

Art.1845

Fenstergriff 60mm
 Rosette 70X45mm
 Window Handle 60mm
 Rosette 70X45mm

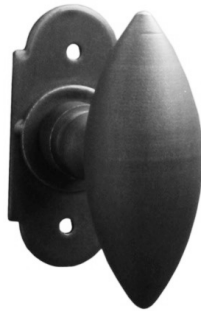
Art.1844

Fenstergriff 60mm
 Schraubabstand 43mm
 Rosette 66X30mm
 Window Handle 60mm
 Axe 43mm Screws M5X30
 Rosette 66X30mm

Art.1846

Fenstergriff 60mm
 Schild 135X35X11mm
 Window Handle 60mm
 Plate 135X35X11mm

Hacken - Hooks



Art.2938
 56 mm
 Rosette ø 50 mm



Art.2937
 100 mm
 Rosette ø 50 mm



Art.2927
 160x35mm



Art.2928
 160x35mm

Schutzgarnituren mit Sicherheitsrosette –



Security door handle sets



Art.2920

Knopf/Knob: Ø 58mm –
Drückerlänge/Handle: 140 mm
Schild/Plate: 270x40mm



Art.4368

Knopf/Knob: Ø 58mm –
Drückerlänge/Handle: 105 mm
Schild/Plate: 220x40mm



Art.4370

Knopf/Knob: Ø 58 mm –
Drückerlänge/Handle: 115 mm
Schild/Plate: 220x40mm

Fensterbänder – Window hinges

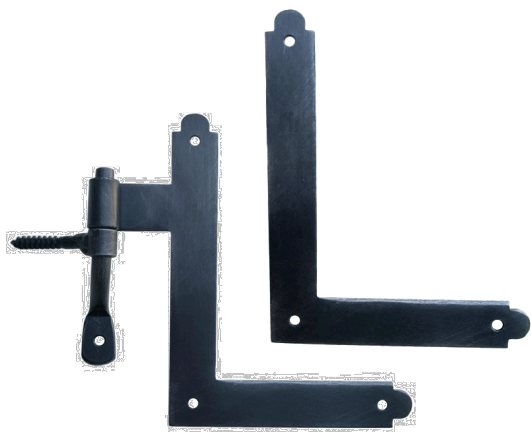

Art.1780- 1782
100x130 mm



Art.1770 - 1772
130x180 mm



Art.1785 - 1787
130x180 mm



Art.1783
140 mm



Art.1773
180 mm



Art.1788
180 mm

MADE IN ITALY



Farb-Beispiele - *Our finishes*



Antik schwarz
Antique Black



STRONG BLACK®



Antik gerostet
Antique Rust



Stahlgrau verzinkt
Silver Zinc (Pewter)



Schwarz/Silber-verzinkt
Zinc-plated



Bronze schwarz
Bronze Black



Antik Eisen grau
Antique Grey Iron



Kupfer schwarz
Copper Black



Antik Weiss
Ant. Gold-White



Gold grün
Ant. Gold-Green



Antik Blau
Ant. Gold-Blue



Gold rot
Ant. Gold-Red

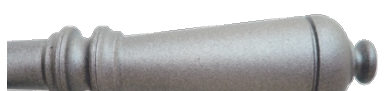

Licht grau
Light Grey GF



Antik Gold
Antique Gold

Galbusera Giancarlo & Giorgio snc

Via G. Verdi 10

23868 ♦ Valmadrera ♦ (Lc) ♦ Italia

T: + 39 0341 58.12.84

F: +39 0341 20.10.68

E: mail@galbuseragg.it - info@antikbeschlaege.biz

W: www.galbuseragg.it - www.antikbeschlaege.biz

Händler / Dealer: